



**TANGGRIP IQ**  
350 LINE

WELCOME  
TO **ISCAR'S**  
WORLD

Sept 2017

Member IMC Group  
**iscar**  
[www.iscar.com](http://www.iscar.com)

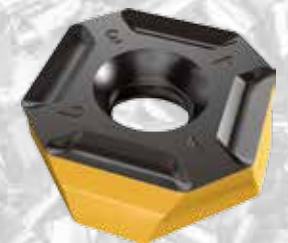

**DOVE IQ MILL**  
845 LINE



**DOVE IQ TURN**  
HEAVY DUTY LINE



**CHAM IQ DRILL**  
700 LINE

# Table of Contents

Oil & Gas: Overcoming the Crisis	4
Milling Aluminium Intelligently	14
Competing with the Unbeatable!	20
A Welcome Power Cut	26
ISCAR Whisper - A Quiet Revolution in Anti-Vibration Tools	32
High-Technology Simplicity	38
Paper VS. Electronic	44





# Oil & Gas Industry

## Overcoming the Crisis



Following a long period of elevated activity driven by high prices, the global oil & gas industry recently experienced a time of extreme change.

The changes in economic growth, combined with OPEC (Organization of the Petroleum Exporting Countries)'s decision at the end of 2014 not to reduce production, ultimately led to a drastic drop in the price of oil a year later - to under US\$40 per barrel.

The effects on oil and gas producers were dramatic and many existing projects began to

make little or no economic sense. Countless companies reduced their expenditure in order to help maintain profitability and assist in curtailing losses. Many major projects were cancelled or postponed and proposed mergers and acquisitions in the oil & gas industry collapsed as sellers and buyers were unable to settle on a mutual agreement.

While oil prices have risen again, many in the industrial world have been confronted with an indisputable agenda: to lower production costs while improving efficiency and all on a huge scale.

Pipes



Rock Bits



Coupling Sleeves

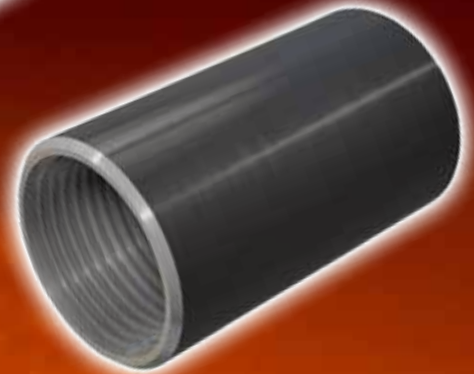

In response to the need for reducing machined part costs as an essential part of overall production cost economization, ISCAR developed a new generation of advanced cutting tools to optimize manufacturing processes and reduce cycle times, without compromising on quality or durability.

These tools may appear to be more expensive, but they deliver significant savings. Although cutting tools represent only 2-4% of total production costs, they have a massive effect on the overall efficiency of a process.

The use of today's minimally more expensive, innovative tools that deliver longer life, ensure faster cycle times and guarantee the continued quality of machined parts, makes solid economic sense.

The application of increased cutting speeds, in addition to the use of custom solutions (combination tools) that enable multiple steps to be combined into one, results in significantly reduced cycle times.



Decreased machine, labor and administrative costs deliver total cost savings as well as the benefit of improved lead times. The result - added capacity and improved productivity!

**ISCAR** offers a range of innovative tooling solutions that are designed to simplify production, reduce costs and maximize productivity. Solutions with leading **SUMOTEC** Grade products provide improved tool life and enhanced reliability across a range of different materials. In addition to a comprehensive collection of cutting tools, **ISCAR** also provides superior technical support to all users.

## Machining Solutions for Oil Country Tubular Goods

### Tubing, Casing, Coupling, Line Pipes, Drill Pipes and Rotary Drill Bits

The aggressive conditions encountered in the oil & gas industries necessitate the use of the most appropriate high-quality materials; as a result these challenging materials require the use of the best available cutting tools.

Innovative system solutions by **ISCAR** include tools for pipe end machining seamlessly hot-rolled or welded steel pipes, for turning, peeling the cone, seal seat machining and thread connections.

The **SUMOTEC** grade technology offers a new level of toughness and wear resistance for a wide range of applications and greater performance.



### Parting Tubes and Rings

Tailor-made tooling combined with the revolutionary **TANG-GRIP** system, an extremely rigid clamping arrangement that ensures the highest levels of stability along with excellent chip control in most of materials, enables machining at high feed rates and provides excellent straightness and surface finish characteristics. Included is a wide range of engineered holders and blades for parting tubes.

### Turning and Threading

External and internal rough turning operations require a high quality surface and consistent results. **DOVE IQ TURN** and **HELITURN TG** is a heavy duty **ISCAR** range of turning inserts ideal for high feed and rough turning operations, providing the benefits of a high depth of cut and high feed rates.

Multifunction tools for turning and threading operations are accurate indexing tools for a wide range of tubing and casing applications to reduce cycle time and increase productivity.

This product range provides tool solutions for high-performance thread cutting machines for API and premium threaded tubing and casing connections.

- Wide solution for API and premium threading
- High precision engineered tooling
- Optimized grade and geometry range for different materials



### Multi-Tooth Threading Inserts and Chasers

Multi-tooth inserts are specially designed for high-volume production. Less passes are needed to cut the required thread and the cycle time is substantially decreased. **ISCAR** offers a wide range of threading inserts and chasers for the oil & gas industry, dedicated for the most common API standard threads and premium profiles.

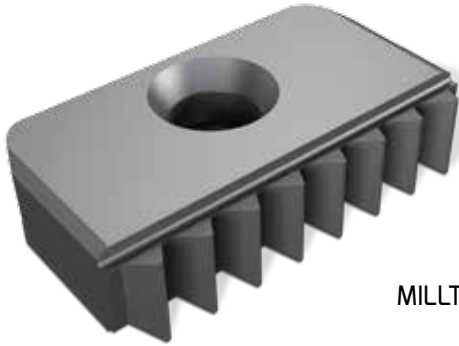

MILLTHREAD

### External and Internal Skiving of Welded Seam

**ISCAR**'s scarfing solutions consist of both external and internal tools, in addition to the comprehensive range of indexable scarfing inserts for finishing operations of the welded joint.

### Rock Drill Bits

Drill bits are cutting tools used to remove material through a cutting action provided by cones which have either steel teeth or tungsten carbide bit inserts.

The **SUMOCHAM** Chamdrill Line comprises a revolutionary clamping system that delivers improvements in productivity, while enabling more insert indexes. **ISCAR** offers tailor-made inserts with the appropriate point angle, corner radius and accuracy.



SUMOCHAM











Wellheads  
X-MAS Tree



Frac Pump



Pressure  
Valve

## Machining Solutions for Wellheads, Valves and Frac Pumps

### Wellhead and Subsea Equipment

Complex and highly engineered materials have become a standard demand for wellhead and subsea components.

### Valves, Pumps and Connectors

Valves, pumps and connectors are fundamental components in pressure control systems, operating under aggressive conditions on both surface and subsea operations. The high strength of stainless steels, duplex and super duplex alloys with their high mechanical strength, and other exotic materials have long been a focus for **ISCAR**.

In order to meet current and foreseeable challenges, **ISCAR** offers a range of advanced tooling solutions, suitable for machining exotic materials that can withstand deep-water hostile environments. This new generation of tools is an essential solution for productivity improvement in today's oil & gas industry.





COMBICHAM

### Hole Making

**ISCAR's** comprehensive hole making range provides all the tools and technology needed for oil & gas component manufacturing. In this area, the key is to achieve the correct balance between the cutting edge, grade and geometry and the material being machined. **ISCAR** offers a complete package of hole making solutions for various machining challenges with a wide range of drilling tools including solid carbide drills and indexable inserts that meet all of the demands of accuracy and performance.

The **CHAMIQDRILL** features a unique design, utilizing the flexibility of carbide for self-locking and eliminating the need for clamping accessories. The robust structure of the drill with its concave cutting edge design enables drilling at high feed rates, providing very accurate adherence to tolerance.



CHAM-IQ-DRILL

The **SUMOGUN** is the only gundrill in the market with an indexable drilling head. It features two effective cutting edges, enabling the drilling of deep holes at much higher feed rates compared to most other gundrills.

For large diameter drilling applications, the **COMBICHAM** drilling system is the ideal solution to boost productivity and efficiency in oil & gas deep drilling applications.



MULTI-MASTER

### Milling

Innovation has always been an essential part of **ISCAR's** milling range. All areas of oil & gas component machining can benefit from our knowledge. Cutters for face milling, helical interpolation, slotting, shouldering, plunge milling, high speed machining and many more solutions are available, along with the advice needed for their successful application.

### Thread Milling

Solid thread milling cutters are available in addition to thread milling indexable inserts for different thread profiles, providing a flexible and efficient approach for high-quality threaded holes. This approach enables the production of precision threads, eliminates the problem of broken taps, reduces cutting forces and delivers shorter cycle times and increased productivity.

### **Solid Carbide End Mills - CHATTERFREE**

**ISCAR's** "all-in-one" solid EFP carbide cutter is based on the most advanced machining technology, with its high-tech design providing a great advantage when cavity milling. A winning combination of **ISCAR's** three most innovative endmills, its unique cutting edge geometry ensures high stability performance during cutting and the delivery of higher feed rates, even with long tooling overhang. These unique features enable high metal removal rates when machining pockets and cavities in high-temperature alloys. As a result, the cutter delivers a significant reduction in cycle time, increasing productivity.

### **Customized Tooling**

**ISCAR** designed its standard product range to cover all of the most common applications. In addition, **ISCAR** applies its extensive knowledge to develop and produce the best solutions for customers' processes not covered by standard products.

The oil and gas market continues to face many challenges and **ISCAR** believes that effective customer collaboration plays an important role in helping the industry meet these challenges by 'thinking outside the box' to address these requirements and take productivity to the next level.



**increasing  
productivity**

---

**reducing  
time**



# Milling Aluminum

## Intelligently

Milling aluminum appears to be a remarkably easy process. Often, people not directly involved in machining aluminum believe that it's enough to take a balanced, sharp, polished tool rotate it at a maximal speed and set at medium feed - and the material will cut like butter.

In comparison with machining steel, aluminum and its alloys require much less cutting force, and therefore the cutting edge of a milling tool experiences relatively low mechanical loading.

Aluminum exhibits high thermal conductivity and the chips produced when machining aluminum transfer high levels of generated heat, resulting in significantly reduced thermal loading of the cutting edge. Due to these properties, milling aluminum is characterized by extremely high cutting speeds and feeds. However, this does not guarantee that milling aluminum is quite so simple.

The material characteristics of aluminum result in the formation of built-up edge (BUE) when machined. This unwelcome phenomenon increases the mechanical load on the cutting edge, making efficient chip flow more difficult to achieve, affecting the balance of rotating tools and causing the entire machining process to be less efficient.

The evacuation of aluminum chips may also be affected by using the wrong kind of cutting tool. If the volume of a tool's chip gullet (flute) is not sufficient, the long chips during aluminum milling will clog the tool. Overcoming this obstacle demands the use of a tool with less teeth or



reducing the applied cutting data; actions that negatively impact productivity.

From a machinability point of view, aluminum is not a material that is uniform. Alloying elements (in particular, silicon), material type (wrought, cast) and treatment methods all affect cutting properties. Other factors such as the shape of a machine part, workholding conditions and operational requirements (accuracy, roughness, etc.) add their own limitations and must be considered when choosing machining strategies and selecting a tool.

Machining aluminum in general and milling aluminum in particular are often not the simple tasks they appear to be. Tool manufacturers need to take the specific features of milling

aluminum into consideration when developing cutters. A key to success is the correct combination of cutting geometry, tool material and tool treatment, in addition to the options for delivery. When considering applications for milling aluminum, large aircraft components, such as wing elements, door or window frames, etc. come to mind. Generally, these parts are produced from whole blocks, often weighing several tons, and it is often necessary to remove up to 80-85% of the block weight to produce the final required shape of a component. In contrast, in the global automotive industry, which is also a massive consumer of aluminum, has introduced various hard cast aluminum grades to their components. The increased abrasiveness of these parts negatively affects tool wear.

A key to **success** is the correct combination of **cutting geometry, tool material and tool treatment**



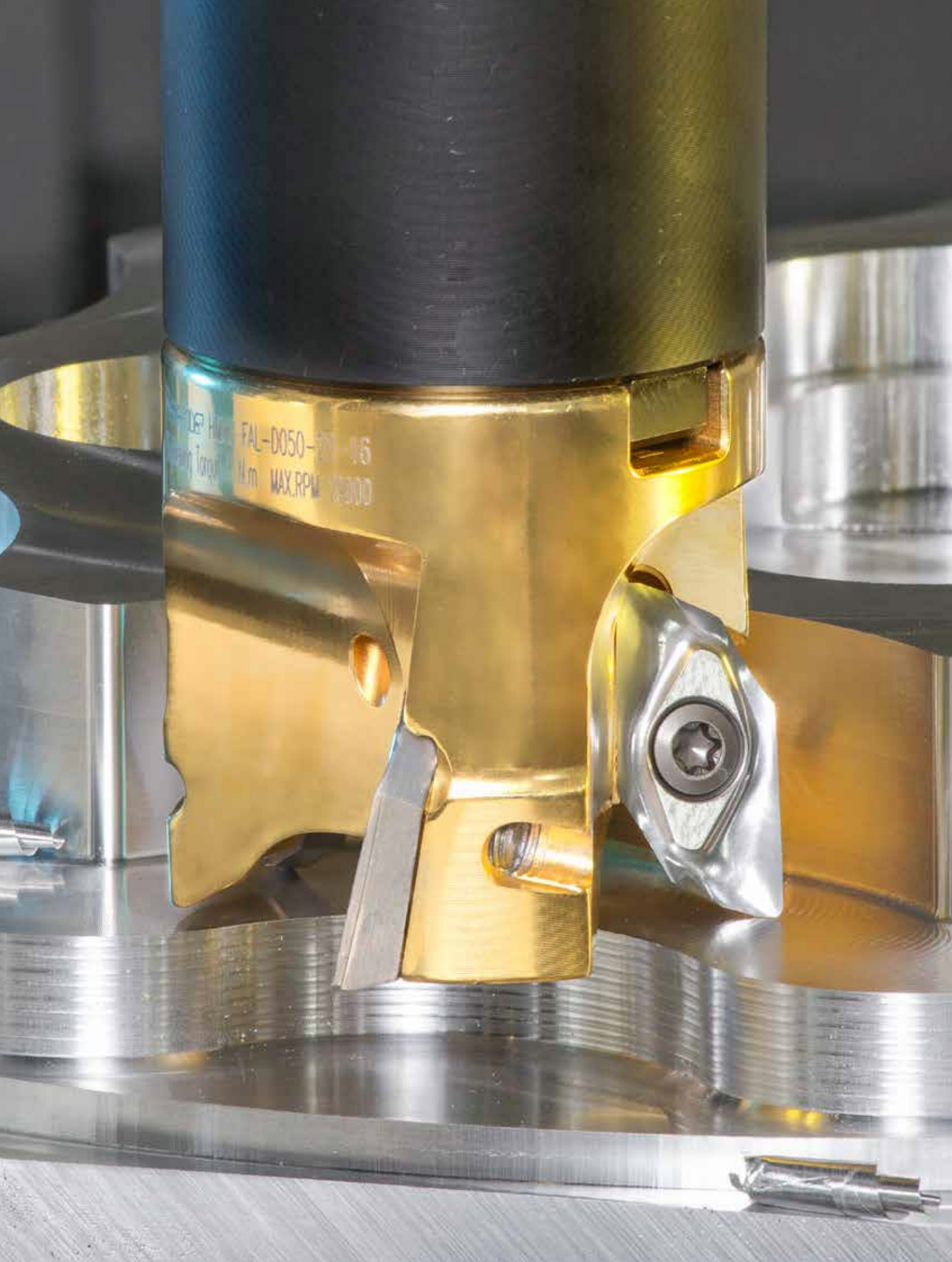

FAL-D050-16  
MAX.RPM 2000





**ISCAR** has developed an entire comprehensive range of indexable milling cutters, designed specifically for the efficient machining of aluminum. Each family of these high-quality cutters features integral or lightweight body designs, unique principles of carbide insert clamping, structures with adjustable cartridges, various ground and polished inserts with different corner radii and,

most popular in aluminum machining, inserts with polycrystalline diamond (PCD) tips. The vast majority of the cutters have inner channels for coolant supply through the body. The **ISCAR HELIALU** line of indexable milling tools enables efficient high speed machining (HSM) of aluminum, ensuring powerful metal removal rates (MRR), high accuracy and excellent surface finish characteristics - all of the qualities demanded by the world's producers of aluminum components.



Metalworking industries produce large and small aluminum parts, and in many cases require milling cutters with more modest dimensions.

The size of these tools is not suitable for indexable inserts and solid carbide tools have distinct advantages. Moreover, the high accuracy of solid carbide endmills renders them beyond comparison when used in precision finishing of larger components. **ISCAR** remains heavily involved in the design and development of advanced solid carbide tools for the milling of aluminum. Recent progressive additions to this comprehensive range have further increased their value to users throughout the industrial world.

**ISCAR's ECR-B3-R-C** family of 3-flute, solid carbide endmills are designed for rough machining at high MRR. The innovative endmills have serrated cutting edges that divide wide chips into narrow chips that are easily evacuated. Inner coolant channels directed to each cutting edge enables the delivery of uninterrupted coolant flow to the cutting zone. These two design features, in combination with polished flutes, significantly improve chip

evacuation abilities, allowing considerably increased productivity. The serrated edge that chops the chips also enhances vibration resistance and, together with the relieved neck of the endmill, contributes to stable cutting under high tool overhang conditions.

Why does the **ECR-B3-R-C** family have 3 flutes and no more? In milling aluminum, chatter and unwelcome vibrations that are generated during the cutting process are a factor of primary importance. Various researches and metalworking practice show that a 3 flute configuration is the optimal design for 90° solid carbide endmills for machining aluminum. In high-efficiency milling, this arrangement ensures a flute volume that is necessary for chip flow while not increasing chatter. The majority of the endmills for use on aluminum are based on this approach and **ISCAR's ECR-B3-R-C** is no exception.

CHATTERFREE



At the same time, the desire to increase the productivity of endmills led to the launch of an innovative 4 flute **ISCAR** design. **CHATTERFREE ECA-H4...CF** is a family of endmills that provides an extra flute to help increase MRR for both roughing and finishing operations. Although a 4 flute structure, these endmills have impressive vibration dampening abilities due to the inclusion of a non-equal flute helix and the variable angular pitch of its teeth. Also, **ISCAR's** tool designers succeeded in creating a core diameter and the cross-section area of a flute similar to the already existing 3 flute endmills of the same diameter from the **ECA-H3** family.

The die & mold and aerospace industrial sectors need small-size milling tools for the precise machining of 3-D surfaces. A newly introduced family of solid carbide ball nose endmills **EBA-B2**, with polished flutes and a diameter range of 1-6 mm, is intended precisely for these kinds of demanding applications. The new family extends the lower range of the 8 to 25 mm diameter **MULTI-MASTER MM EBA** replaceable ball nose heads.

The **MULTI-MASTER** family of assembled tools, comprising shanks of different configurations and a great variety of replaceable cutting heads, is ideal for milling aluminum, especially in applications requiring the high overhang of a tool. Long-reach solid carbide endmills are produced from expensive carbide rods of considerable overall length. Despite the small fluted part of an endmill being directly involved in cutting, after tool wear or a sudden breakage, the whole expensive rod needs to be thrown away. This is a serious economic disadvantage. In contrast, in such cases, **MULTI-MASTER** users only need to replace the cutting head.

Milling aluminum is easy if performed intelligently! Apply an efficient cutting strategy and use **ISCAR's** correctly chosen milling tools for successful results.



# Competing with the Unbeatable!

Titanium Milling  
with ISCAR Tools



The remarkable strength-to-weight ratio and high corrosion resistant properties of titanium have resulted in the ever growing use of this important engineering material in many demanding sectors, not least the global aerospace industry.

The production of critical structural parts from titanium ensures their required performance and reliability whilst significantly reducing component mass. Although relevant to all users of titanium, the enhanced strength and reductions in weight that the material delivers are of particular importance to the aerospace industry, as these advantages improve aircraft performance and increase fuel economy.

The negative trade-offs produced by the use of titanium are the many problems encountered when machining this difficult-to-cut material. When used in metalworking industries, the word "titanium" normally relates not only to pure titanium but also to titanium alloys. There are several groups of titanium: commercially pure titanium (unalloyed),  $\alpha$ -,  $\beta$ -,  $\alpha$ - $\beta$ - and other alloys. It is sometimes stated that titanium machinability is similar to that of austenitic stainless steel. This proposition is more or less true if it relates to commercially pure titanium, although it is totally wrong with respect to treated  $\alpha$ - $\beta$ - and especially  $\beta$ -titanium alloys.



Machinability rating depends heavily on the type of titanium and its treatment. The machinability of the widely used annealed titanium TiAl6V4 is approximately 35-40% less than annealed stainless steel AISI 304. However, if we take the machinability of the aforementioned titanium grade as 100%, the so-called “triple 5”, titanium 5-5-5-3, a major manufacturing headache for many machine shops, features machinability characteristics that are twice as difficult.

one-hit production methods. However, the typically low cutting speeds used in the machining of titanium severely limit machine tools’ efficiency potential and results in the cutting tool becoming the weakest element of the whole technical production system. In short, the cutting tool determines the productivity boundaries when machining titanium and, as such, has become a major factor in the quest for a radical improvement of this situation.

# Machine tool manufacturers continue to introduce innovations and developments that make the cutting of titanium more effective

Machine tool manufacturers continue to introduce innovations and developments that make the cutting of titanium more effective. Modern machine tools allow operators to apply advanced machining strategies and to employ

Due to the low thermal conductivity of titanium, the main problem in cutting this material is the generation of heat. Poor heat transfer leads to considerable thermal loads being directly transferred to the tools cutting edge.



In addition, titanium's modulus of elasticity contributes to vibration during cutting and, as a result, surface finish and accuracy problems can be encountered (This is less of a problem when machining steel).

Cutting tool producers continue to place a greater emphasis on developing progressive tools for the efficient machining of titanium. Manufacturing titanium parts is a process with significant buy-to-fly ratio, when a large amount of metal needs to be removed. The eventual weight of a finished titanium part may be only 10%, or less of the original weight of a workpiece. Frequently, these parts will have cavities, pockets and ribs that dictate milling as the main method for manufacturing. As a consequence, every new tool that is intended for the milling of titanium creates intense interest amongst the global technical community. The latest products from **ISCAR**, an acknowledged innovator in the field, always attract the attention of the world's manufacturers involved in machining titanium.

Tool material is of fundamental importance in the success of cutting tools, especially for use with indexable milling difficult-to-cut aerospace materials, in particular titanium. Within this challenging field, **ISCAR** has developed a new carbide grade IC840. The word "new" relates to all grade elements: IC840 is characterized by a newly cemented carbide substrate and an innovative hard PVD coating. The grade substrate is highly resistant to thermal cracks; the bronze-color, "chocolate", coating boasts high oxidation and chipping resistance whilst an advanced post-coating treatment improves overall toughness. The advantageous combination of IC840 provides users with great opportunities in milling titanium. **ISCAR** believes that the new "chocolate" will definitely suit the taste of the manufacturer of titanium components and increase the performance of indexable cutters.



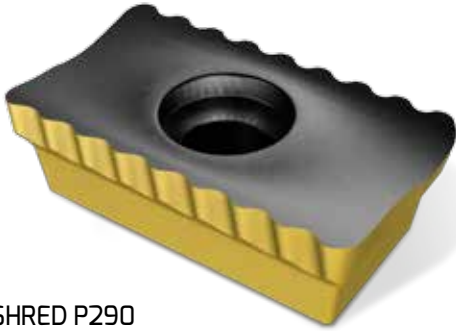

MILLSHRED P290

Milling titanium usually involves removing considerable stock. True “workhorses” in this field are extended flute indexable tools (porcupines) that are intended for the rough cutting of deep pockets, cavities and wide edges. For these operations, **ISCAR** has developed the **HELITANG T490**, a family of advanced milling tools with tangentially clamped inserts, and also the **MILLSHRED P290**, a range of milling tools carrying serrated inserts that provide an efficient chip splitting (even chip chopping) effect. In addition, the company offers **HELITANG FIN**, a family of tangential porcupines that was designed especially for semi-finish milling.

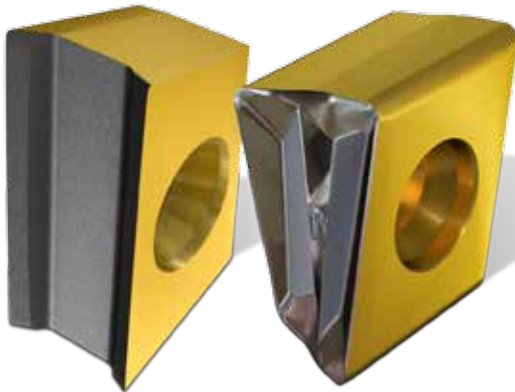

HELITANG FIN

HELITANG T490

**ISCAR** has recently introduced a new group of extended flute shell mills related to the proven and popular **HELIQUAD** family. These mills carry one-sided square inserts, which are clamped radially. Why has the company, so well known for its commitment to innovative advantageous cutting geometries, equipped the new mills with “traditional” simple square

inserts? The deceptively simple, new extended flute tools feature a well-designed structure resulting in significantly improved dynamic rigidity and anti-vibration strength. In addition, radial insert clamping enables the inclusion of a chip gullet with a generous volume that answers the requirements of free chip flow when milling at high metal removal rates (MRR). Also, the tools of more popular diameters have internal channels, which are specially designed for machining with a high-pressure coolant (HPC) supply. Even these “simple” square inserts are characterized by a progressive cutting geometry that provides effective titanium milling.

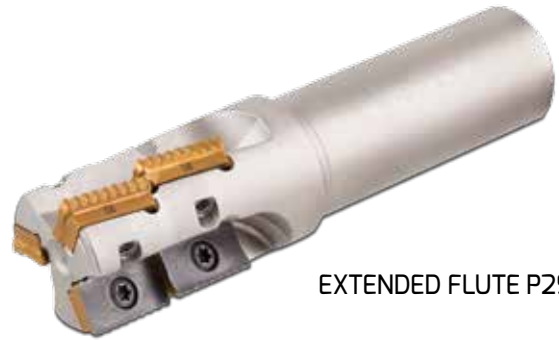

EXTENDED FLUTE P290

While **HELITANG T490** and **MILLSHRED P290** are intended for productive roughing, and **HELITANG FIN** for qualitative semi-finishing of titanium workpieces, the new **HELIQUAD** (real HELIQUAD) extended flute shell mills provide high-efficiency milling with resulting surface conditions close to semi-finish conditions.

TI-TURBO



**ISCAR** recently introduced the **Ti-TURBO** family of solid carbide endmills in a diameter range of 6 to 20 mm. The new family was designed for finishing operations and also for high-speed



machining (HSM) of mainly slots, with the use of the trochoidal technique. Trochoidal milling features a small width and significant depth of cut, combined with a tool path dictated by a trochoid curve. Under such conditions the tool “slices” metal up at a high rate. The engagement angle here is small and produced chips are very thin. This results in dramatically decreasing the thermal load on the tool. **Ti-TURBO** endmills, of unique patent design, have 7 or 9 variable flutes with variable angular pitch (similar to **CHATTERFREE** solid carbide tools) that ensures powerful resistance to vibration. That is why the new family is considered a true turbo booster in the area of titanium milling.

**ISCAR's MULTI-MASTER** versatile line of assembled tools with replaceable solid carbide cutting heads, has been recently enhanced by the introduction of new, six-flute, fast feed milling heads with central coolant holes.

The ultra-fine grain carbide substrate of the heads protected by the advanced AL-TEC coating technology, provides outstanding wear resistance and toughness. The heads are used in productive high feed milling (HFM), resulting in significant reductions in the cycle times of roughing operations.

**Over 15,000  
Combinations  
of Assembled Endmills**

Manufacturers of titanium parts are constantly placing new demands on cutting tool producers. In order to meet these challenges, cutting tool producers are forced to think out of the box on a regular basis. **ISCAR's** R&D team continues to cooperate with many of the world's leading manufacturers of titanium parts to ensure that the company retains its lead within this challenging sector.



# A Welcome Power Cut

The quest for reducing levels of power consumption in the global metal cutting sector is not a new trend; today it has become an essential technical requirement. Industry's greater understanding of its environmental protection and sustainability responsibilities has ensured the development of processes, materials and machines that significantly reduce power consumption during machining operations.

In addition to ensuring more efficient machining strategies when compared to their heavy-duty predecessors, modern machining centers require less power whilst delivering improved performance capabilities.

Previously, a typical production process was divided into primary and final cutting tasks that were performed on two machines. The first powerful machine removed most of the stock, and a more precise procedure was then used to achieve the final required shape and to create the necessary surface finish. Today, a single process often achieves these results in half the time. Fast and less load machining results in increased productivity and consumes less cutting power. In addition, the reduction of power means that the forces acting on the machine's main units (spindle,



guidelines, etc.) are cut, which improves tool life and makes machining much more accurate and predictable.

Cutting tools have a major role to play in this area. Total power requirements can be moderated by the use of advanced new tools and innovative milling tools offer promising opportunities in particular.

### Leading-edge cutting geometry

When milling, power consumption depends on several parameters, including workpiece material, depth and width of cut, cutting speeds and feeds. A combination of these influences defines the material's resistance to machining, and the total cutting force generated during the process. There is another important factor closely connected with these forces – the geometry of the tool being used; more specifically, the tool rake angles in both normal and axial directions.

The standard rake significantly affects the tangential cutting force and is the main determinant of the cutting power required if all other parameters are equal. The axial rake has an effect on resolving the total cutting forces into components and acts on the tangential cutting force as well. With respect to milling cutters

carrying indexable inserts, the rake angles are defined by the topology of the insert rake face and the insert positioning in the cutter. The topology is a key factor in varying rake angles.

In the early nineties, **ISCAR** introduced the **HELMILL** – a family of milling tools carrying indexable inserts with a helical cutting edge.

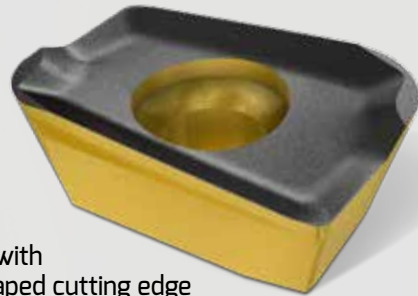

HELMILL with helical-shaped cutting edge

The highly effective edge was generated by the intersection of the shaped insert top (rake) face and the helical insert side (relief) surface. The design of the **HELMILL** tools formed a constant positive normal rake and a positive axial rake along all cutting lengths. This feature immediately caused a significant reduction in power consumption and ensured a smooth cut. **HELMILL** heralded a new design approach that is considered today as the acknowledged format in indexable milling, and put the shaped rake face of an insert into the forefront.

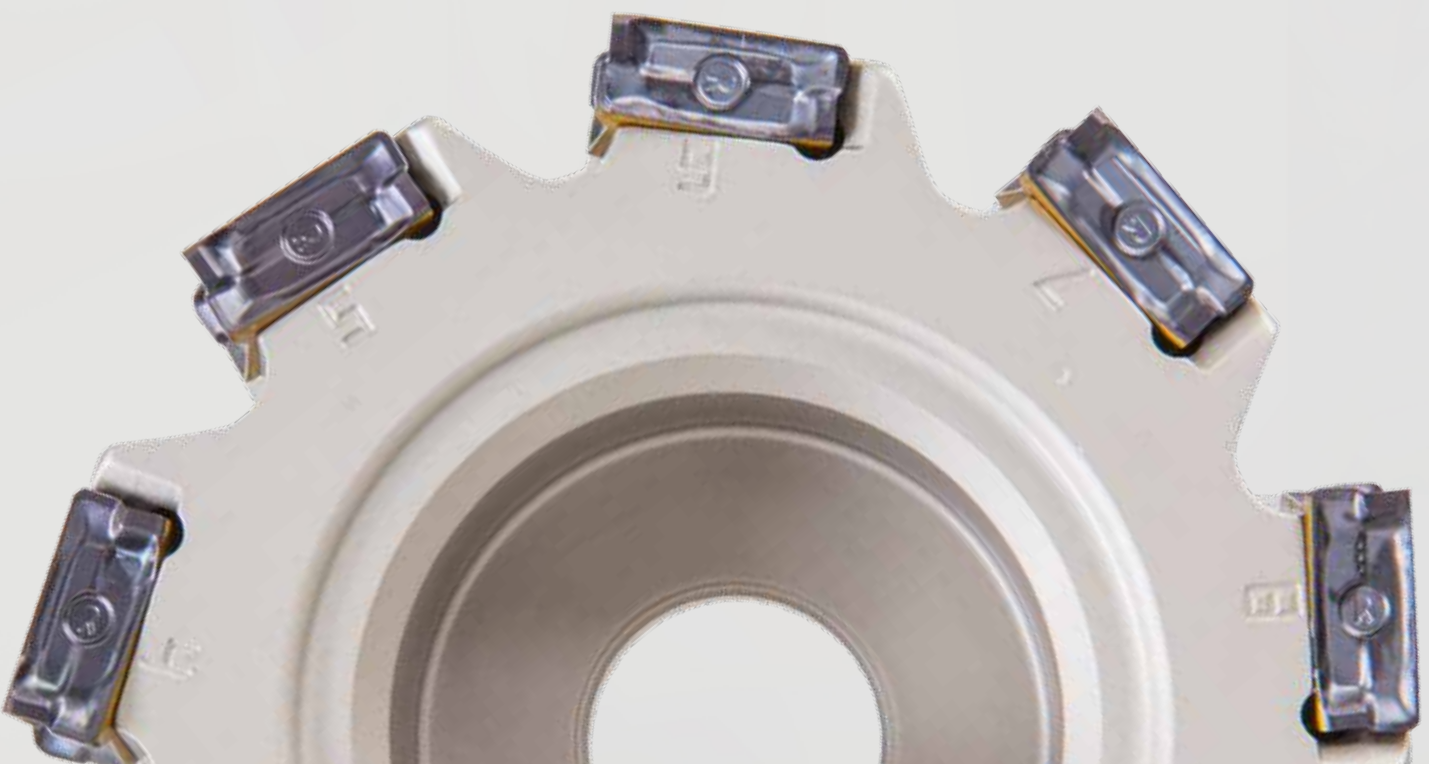



Grade Powders

When attempting to increase the rake, a tool designer seeks to incline the rake face of an insert more aggressively with respect to its cutting edge. However, in this area there is a serious limitation in that this incline weakens the insert's cutting wedge and therefore has a negative impact on strength.

The helically-formed edge causes a difference between the heights, which are measured in adjacent corners of the insert. Producing such uneven sintered products is not a simple task and its creation requires serious technological efforts.

TRIGON with steeply inclined rake face



Today, advances in powder metallurgy provides many more opportunities for increasing both the inclination of the rake face and the helix angle of the cutting edge, all without loss of strength. **ISCAR's** insert **H690 WNMU 0705** is a good example of a steeply inclined rake face of an insert with a difference in heights that enables lower power consumption. The increasing use of the term "high positive", when describing modern milling inserts, emphasizes the dynamic changes in indexable topology. Such a definition reflects the current state of the art. As the production of tools with cemented carbide inserts does not deplete topology resources, the "high positive" of today could be considered as "normal" tomorrow. Increased optimization of the topology will lead to an additional reduction in cutting power.



### Faster with lower power demand

It is commonly believed that machining at full capacity is an effective means for improving productivity. Rough milling deep cavities with the use of extended flute cutters or face milling by large-sized shell mills at a large axial depth of cut, when stock per pass is considerable, are typical examples of such an approach. These operations provide a high metal removal rate (MRR) but are power-intensive, as milling under such conditions requires a significant cutting force and necessitates the utilization of machine tools with heavy-duty main and low feed drives. In this case, high efficiency is ensured by removing material of maximum possible cross-section at low to medium feeds.

At the same time, another rough milling technique proposes a diametrically opposite principle: the combination of a rapidly running tool with a shallow depth of cut. In this case, power consumption drops dramatically with no loss in productivity – the tool works at

extremely high feeds guaranteeing efficient metal removal. This energy-saving shallow-cut “fast” technology provides a good alternative to power-consuming deep-cut “slow” technology. High feed milling (HFM), which can be successfully realized on modern, light-duty fast moving machines, has delivered a serious and sustainable alternative to the traditional yet power-consuming approach.

HFM (“fast feed”) tools feature specific geometry. **ISCAR** offers them in all of the company’s milling lines: indexable, solid carbide and Multi-Master (a family of assembled tools with replaceable cutting heads produced from cemented carbides).

In addition, **ISCAR** has introduced inserts that, when mounted on general-use indexable endmills or face mills, turn into HFM tools. Such a transformation is a way to simply adjust various cutters from **ISCAR**’s standard line for fast feed milling.

## Alternative machining strategies challenge deep-rooted techniques

*Substantially expanded opportunities for modern machining tools have led to new milling strategies that, amongst other advantages, reduce power consumption.*

An example is turning heavy-weight parts. When turning, cutting speeds are traditionally ensured by rotating a part. If the main drive of a machine tool is unable to rotate a part of large mass with the required velocity, the achieved cutting speed will fall short of the necessary range. Such a limitation causes a loss in performance in turning operations.

Today, advanced multifunctional machining tools offer an effective solution: turn-milling, a method combining milling and turning, where a milling tool cuts a rotating workpiece. The majority of **ISCAR** indexable face mills and endmills can be applied to turn-milling; however, correct tool positioning

and the calculation of cutting data require a more profound understanding of the specific features of this process.

The conventional milling of slots or grooves starts from the machining of solid material directly at full tool engagement. Milling with full tool engagement requires increased cutting forces and, as a consequence, consumes more power. A high speed trochoidal milling technique can be an effective alternative to the common slot milling strategy. In trochoidal milling, a rapidly rotated tool machines the slot by arc motion at a significant depth of cut and very small width of cut. The tool slices thin layers of material with both high speed and high feed rates.

HELIDO for high speed trochoidal milling

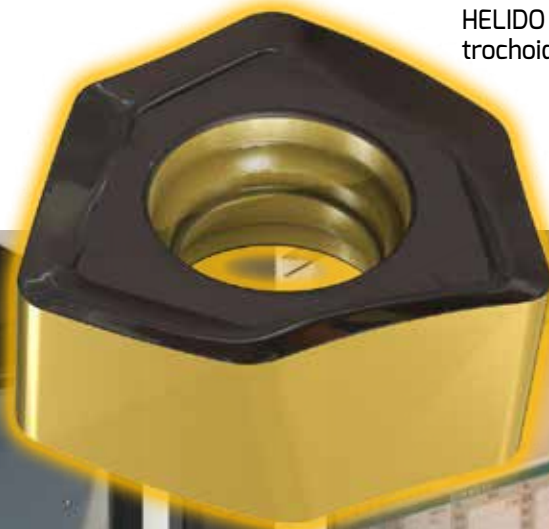

This method enables a noticeable reduction in power consumption. It is no wonder that trochoidal milling has been utilized successfully in manufacturing parts with complicated slots and grooves, such as blisks (bladed disks), blings (bladed rings), impellers, etc., especially those with relatively thin walls.

**ISCAR** has recently introduced **Ti-TURBO** – a family of solid carbide endmills ECK H7/9-CFR that have a unique cutting geometry with 7 or 9 flutes, different helix and a variable angular pitch. The main application of the new family is trochoidal milling workpieces, which are made from difficult-to-cut titanium grades.

Applying new machining strategies with correctly chosen milling tools creates new opportunities for power-saving. Reducing machining power is one of the necessary conditions of modern manufacturing. The latest machine tools provide the metalworking industry with the means suitable for high performance and energy-efficient technology. The sustainable cutting tool not only cuts metal productively but also cuts power consumption – a major factor in **ISCAR**'s success.



Ti-TURBO with unique cutting geometry

The sustainable cutting tool  
not only cuts  
metal productively  
but also cuts  
power consumption

# ISCAR Whisper

A Quiet Revolution in  
**Anti-Vibration** Tools





Throughout the world, machinists have to deal with the presence of problematic vibrations on a daily basis. To help solve these difficulties, ISCAR's Research and Development department has developed a wide range of anti-vibration tools that are able to reduce or even eliminate this challenging phenomenon, across a wide range of machining disciplines. Today, ISCAR's acknowledged expertise in the design and development of anti-vibration tools has been applied to the boring bar.

One of the most common turning applications is the boring of components, a function also known as internal turning. The most widespread tools used for this type of machining operation are boring bars. Boring bars' shapes enable them to operate through previously drilled holes, and to efficiently enlarge and accurately profile holes according to their specific requirements. The correct application of a boring bar enables a bore's internal profile to be machined according to specification, an accurate hole diameter to be achieved and the required surface finish quality to be realized. In order to cover the complete range of applications for internal turning, **ISCAR** has

developed a comprehensive series of high-quality internal boring bars for different insert geometries, covering all machining applications from 4xBD to 10xBD.

**ISCAR** offers three types of boring bars: **solid steel**, **solid carbide** and **anti-vibration**. The maximum overhang for solid steel boring bars is up to 4xBD. This limitation is due to the fact that machining with a longer length of steel shank (more than 4xBD) can induce unwelcome vibrations due to the elasticity and characteristics of the steel.

In order to limit the vibration on a higher overhang of more than 4xBD and up to 6xBD, the use of solid carbide boring bars is recommended. Solid carbide boring bars represent an excellent, highly efficient option for boring applications of up to six times the tool's machining depth. This capability is attributable to solid carbide possessing a coefficient of elasticity that is three times higher than that of steel.

However, when the machining of high overhangs of more than 6xBD is required, even the use of a solid carbide shank can cause vibrations. Therefore, in these cases the use of solid carbide can be somewhat limited.



## Deep turning

Deep turning solutions for machining high depth to diameter internal applications include special anti-vibration boring bar systems with a 'live' vibration dampening system located inside the tool body.

ISCAR's innovative **WHISPERLINE** anti-vibration boring bars have been designed to significantly reduce and even totally eliminate vibrations when working with a high overhang from 7xBD to 10xBD. Situated inside these ingenious tools is a unique damping mechanism that consists of a heavy mass that is supported by a rubber spring element containing oil to increase the required dampening effect.

In addition, the system contains other elements which help to further reduce vibrations. The reactive damping mechanism comes into action during machining with high overhang work depths and acts as an effective counter to vibrations. The highly effective, anti-vibration damper effect is applicable for large D.O.C and high feed rates, and ensures continuous, efficient machining.

ISCAR's inspired **WHISPERLINE** anti-vibration tools considerably improve machining stability and enhance insert life. These factors enable

meaningful increases in productivity to be achieved, improvements in surface quality on high overhangs to be attained, scrap levels to be reduced and users' profitability to be enhanced.

**WHISPERLINE** anti-vibration tools enable the delivery of internal coolant to be supplied directly to where it is required - the insert's cutting edge. The efficient distribution of coolant increases the insert's tool life by reducing temperature and also improves chip control and chip evacuation.

The **WHISPERLINE** anti-vibration turning tool line enables the fitting of a wide range of cutting heads with a range of different insert geometries, including all ISCAR standard ISO turning inserts for different applications; thus offering great flexibility.

The **WHISPERLINE** boring bars represent a cost-effective, modular system with a wide range of standard shanks with diameters of 16, 20, 25, 32, 40, 50 and 60mm. The flexible boring bars are able to carry eight different interchangeable boring heads: CCMT, VCMT, TCMT, DCMT, TNMG, CNMG, WNMG, TNMG, DNMG, SNMG and VNMG.



**WHISPERLINE**  
ANTI-VIBRATION

### Insert geometry

Correct insert geometry is a very important factor when using anti-vibration boring bars. The most recommended insert geometry for successful anti-vibration use, is a positive geometry insert with a positive rake angle, as this shape exerts a lower tangential cutting force when machining.

Choosing the appropriate nose radius of the insert is also a vitally important consideration. A lower nose radius is recommended as this configuration significantly reduces the cutting forces, due to the lower contact between the insert and workpiece, which helps to limit and reduce vibration.

A greater nose radius creates much larger radial and tangential cutting forces that can produce unwelcome vibrations.

The  
**WHISPERLINE**  
boring bars  
represent a  
**cost-effective,**  
modular system  
with **a wide range**  
of standard  
shanks



Inserts with the benefit of appropriate chip breakers are recommended for improved chip evacuation, as the production of long and curled chips can cause a range of problems when working with long overhang tools. In addition to increasing vibration during machining, long and curled chips are liable to spoil or damage the surface quality of the workpiece. Highly recommended **ISCAR** chip breakers for anti-vibration tools are the F3P/F3M for finish machining applications using a small D.O.C.; and the M3P/M3M, for medium applications.



M3M

These highly-efficient chip breakers ensure excellent chip control and the creation of small chips which can be evacuated more easily with the help of the coolant supply.

An additional, very important factor in reducing vibrations is ensuring the clamping stability of the anti-vibration boring bar. Secure clamping helps users to achieve the correct workpiece dimension, which results in excellent workpiece surface quantity and assists in avoiding vibrations; clamping length should be 4XBD.

**ISCAR's** anti-vibration boring bars join the ever-growing **ISCAR WHISPERLINE** family of ingenious tools that are designed for anti-vibration turning and grooving applications. These anti-vibration turning tools can be referred to as tuned or damped tools, which provide effective solutions for the reduction and elimination of vibrations.



**Reducing vibrations  
ensures  
clamping stability**



# High-Technology Simplicity

**A new standard of indexable inserts: a carefully designed complex shape for effective cutting action**

Cemented carbide indexable inserts are an integral part of cutting tools today. Cemented carbide inserts were introduced in the early '60s and have substantially changed tool designs, putting tools with brazed carbide tips on the back burner. Mechanical clamping of the indexable inserts provided significant advantages in productivity, efficient use of carbide and tool maintenance.

Advances in technology and metallurgy have facilitated the development of indexable inserts that are far more advanced than their predecessors, and complicated shapes which have replaced the simple forms that characterized inserts in the past.

The shape of an insert is a key factor for cutting geometry of a tool as a whole. For example, when milling, geometry variation by means of changing the position of the insert in the tool is very limited, and the results are far from optimal.

Effective machining demands constant rake and relief angles along the cutting edge, which in turn necessitate complicated contours of the top of the insert (and also bottom for double-sided inserts) and its periphery. A land that strengthens the cutting edge and a minor edge for better milling by ramping further increases the design's complexity.

*The insert must ensure precise control of the flow of chips produced by the cutting action, and so the chip breaker on the rake face adjoining the cutting edge must be specifically shaped.*

This is particularly important for turning, especially if a machined material produces long chips; here, the chip breaker controls the direction of the chip flow so that the chip overturns and breaks into smaller segments.

Finding the optimal insert shape for efficient cutting and chip control is not a simple task, and tool manufacturers have leveraged new technologies to develop successful solutions.



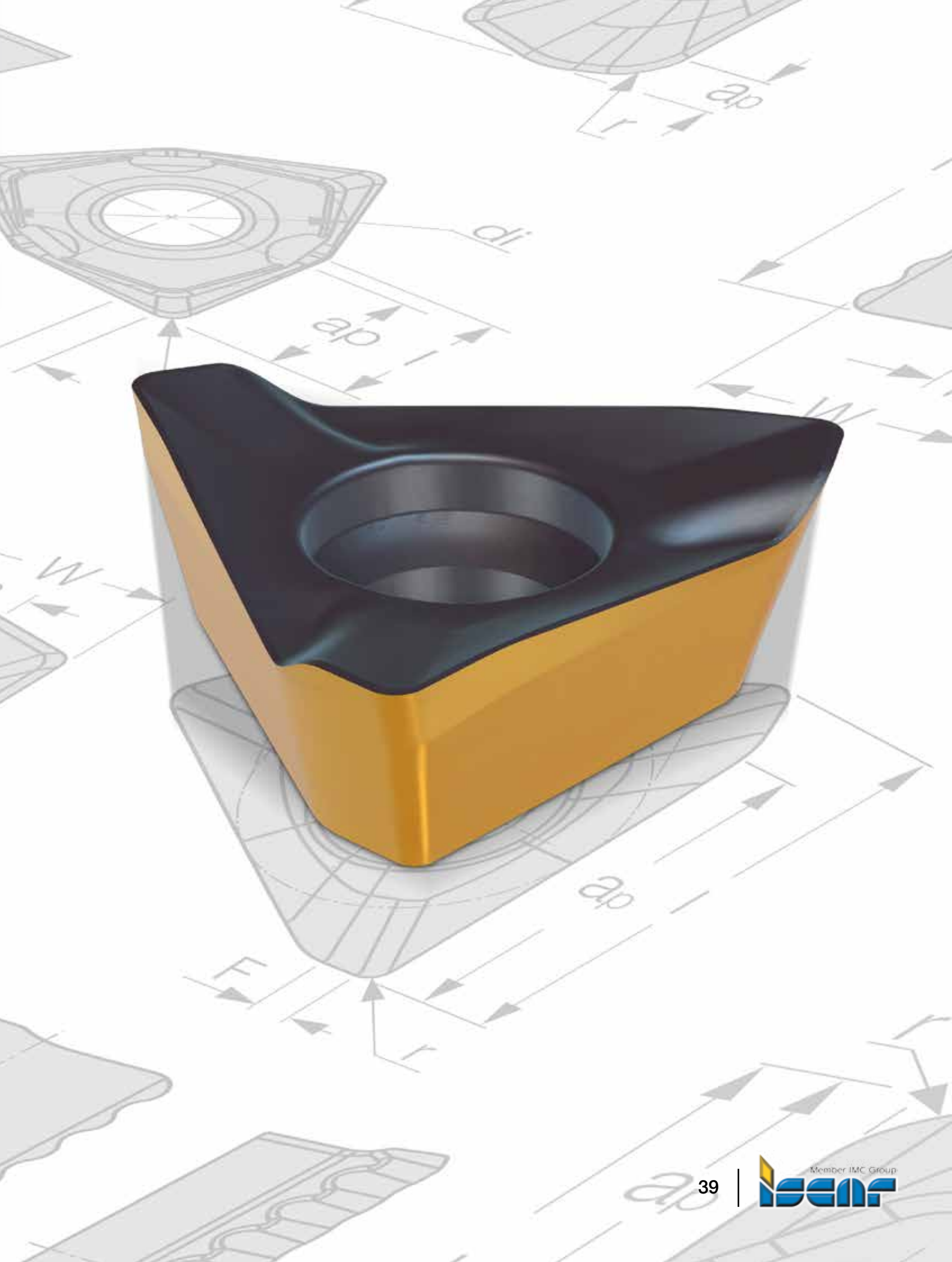



The indexable inserts are sintered products. Integrating dedicated automated and computer controlled systems into the tool fabrication facilities ensured both stability and repeatability in the powder metallurgy processes. As a result, pressing complicated forms became possible without fear of cracks, and a technological base for forming challenging geometries of inserts was developed.

A surface that ensures satisfactory chip control, particularly chip breaking, is a combination of concave and convex elements: grooves, bosses, etc. Manufacturing this surface by grinding is both very limited and expensive. This is one of the main reasons why the first generations of the indexable inserts featured flat forms. In contrast, with the use of powder metallurgy the rake face of an insert can be configured as desired.

Today, cutting tool design engineers have at their disposal advanced working tools such as computer-aided design (CAD) and modeling, which have essentially changed the process of insert development. The new methods have opened up the possibility of simulating various processes, such as chip formation and chip flow. Consequently, an optimal geometry may be designed on a computer by changing various parameters of the virtual insert.

Progress on both fronts - manufacturing technology and design methods - has led to important breakthroughs in the production of indexable inserts.



INSERT FOR STAINLESS STEEL



INSERT FOR STEEL





**ISCAR's** insert **IQ845 SYHU 0704** for face milling cutters is a good example of how computer modeling and advanced pressing have resulted in a successful product.

Computer modeling the chip flow has contributed significantly to optimizing the rake face shape for the family of **ISCAR** inserts **CNMG-F3M** that was designed especially for the finish turning of ISO M materials (austenitic, precipitation hardening and duplex stainless steels).

Powder metallurgy is applied to the face of the insert as well as its cutting edge. For example, the inserts **P290 ACKT** of the **ISCAR MILLSHRED** family possess serrated cutting edges that are used as sintered. The serrated cutting edge shreds the chip and so greatly improves milling results in unstable conditions.

The concept of a cutting tool with mechanically-clamped inserts pushed aside brazed cutting edge applications once the industry learned to produce sintered inserts with acceptable accuracy and dimensional stability. However, for high-precision cutting, rotating solid carbide and also brazed tools still retain the lead. A one-piece integral cutter, ground with strict tolerance limits, always has the advantage in accuracy in comparison with an assembled tool with inserts. There is a viable indexable alternative that not only overcomes the lack of accuracy but improves the tool by making it both versatile and economical: an innovative yet simple modular cutter that can incorporate various replaceable solid carbide heads.

MILLSHRED Insert

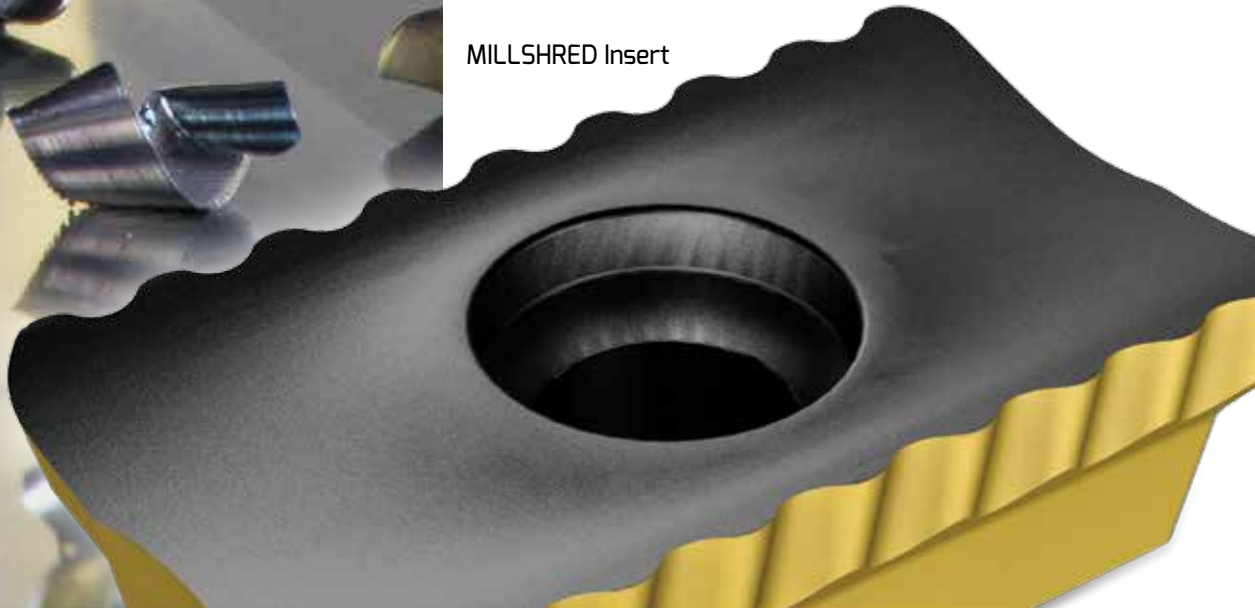

**ISCAR's** tool families target different types of machining: **R** (milling and drilling); **T-SLOT** (milling slots and grooves); **SUMOCHAM, CHAMIQDRILL** and **CHAMDRILL** (drilling); **BAYO T-REAM** (reaming). Manufacturing replaceable heads for the tools is based on technologically-advanced pressing and sintering processes. There are two kinds of heads. One is a tool of decreased length usually made of solid carbide, whereas the second head features a specific pre-sintered shape that is brought to final dimensions by fine grinding.

*Advances in powder metallurgy have influenced the second type of head, while technological progress has succeeded in producing highly specific shapes for improved cutting action and chip control that are very difficult or even simply impossible to reach by using grinding operations.*

The growth of modern technology opened the door for producing both the indexable inserts and the replaceable heads from cemented carbide in diverse shapes. This reflects the outcome of years of research and development in the field, and further illustrates **ISCAR's** commitment to the development of machining performance. Essentially, an indexable cutting tool comprises only three components: the tool body, the inserts (the insert) or the head, and a clamping element.

The carefully shaped cutting area of this modern tool removes material directly despite its small dimension and uniform structure. **ISCAR's** research and development division is committed to the evolution of smart cutting tool solutions and technologies to improve production processes in metal cutting.

The growth of  
modern  
technology  
opened the  
door for  
producing both  
the indexable  
inserts and the  
replaceable  
heads from  
cemented  
carbide



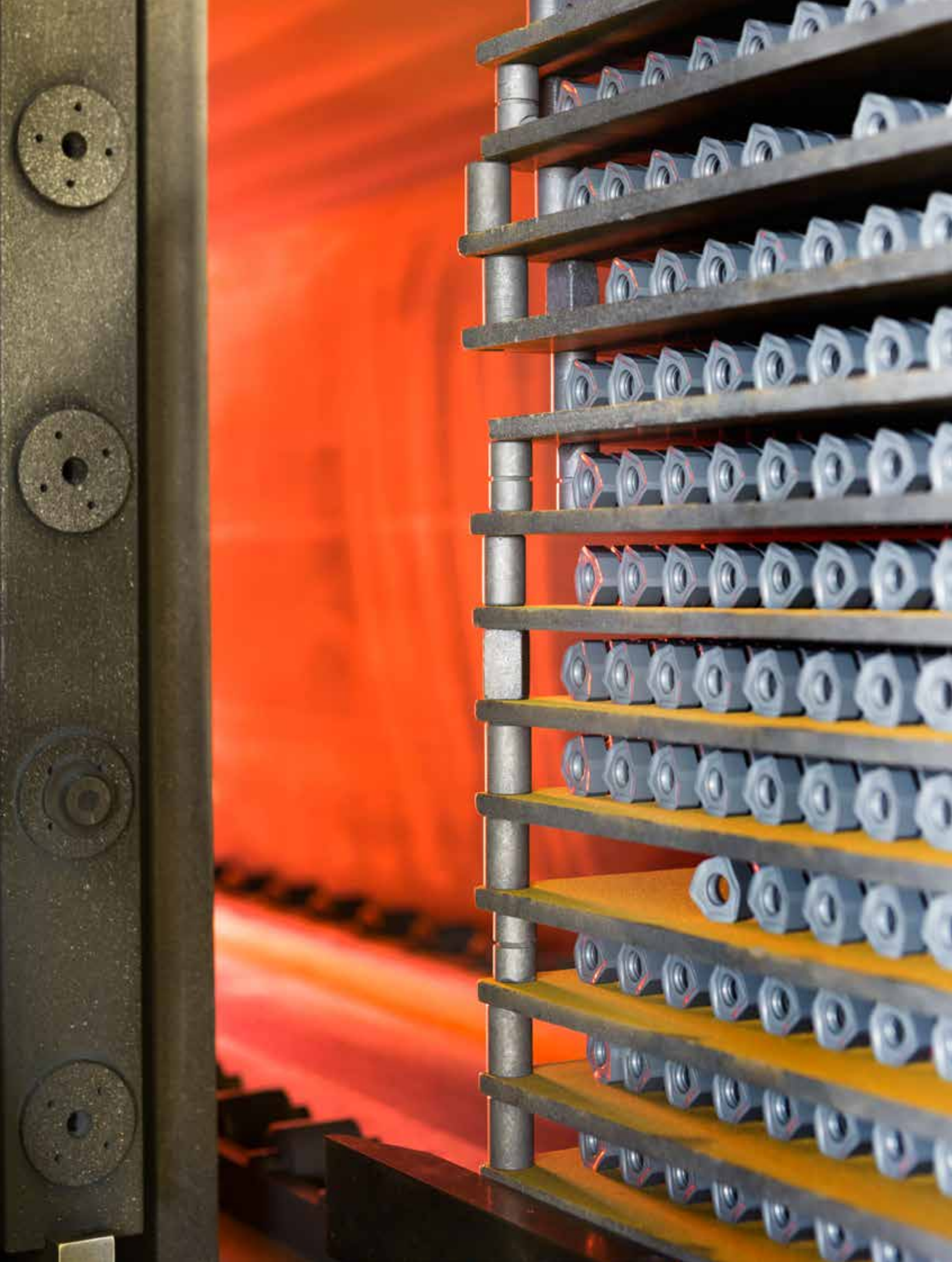

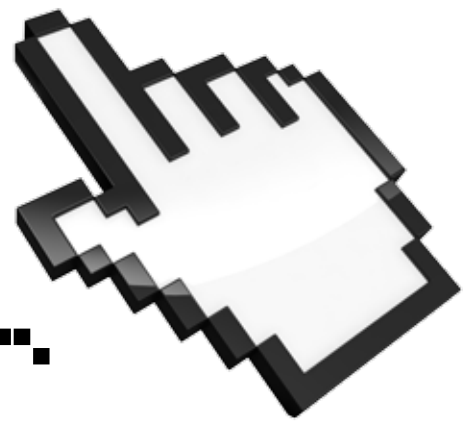
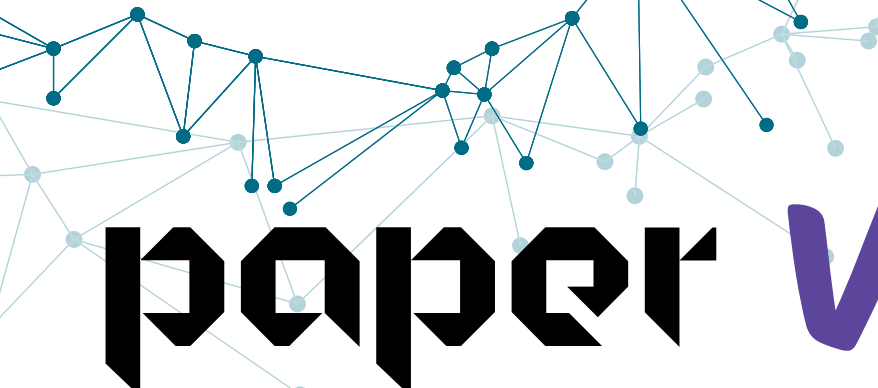

# paper vs. ELECTRONIC

With the launch of the Internet in the mid 1990's, many companies in the metalworking industry discovered that catalogs could be adapted for the World Wide Web. However, they were extremely expensive to publish in this new format and the return on investment could not be justified for that era. Most orders continued to emanate from those people who used paper catalogs. In time, the web catalog proved to be an ordering mechanism and not an effective sales medium.

We learned that customers treat **ISCAR's** catalogs much like a magazine: they are interesting to read and the assimilated information provides a basis for making intelligent purchasing decisions. In addition, a new **ISCAR** catalog has always provided a good reason to visit a customer. The catalog can be carried around and has a shelf life of days, weeks and even years. Many shop floors around the globe do not have internet capabilities, so the paper catalog continues to represent a more popular tool for cutting tool data searches.

A web catalog on the other hand is a very passive device that can be read on a computer or mobile

device screen. It does not reach out to say 'read me', and most people are not even aware when a new version has arrived.

Over time, catalog users have increased their use of the Internet as the data is accessible at all times. Online catalogs have proved to be a more efficient ordering tool for customers, as the optimized search option enables finding the right products quickly and easily. Yet browsing catalogs on the web does not provide the same user experience as does leafing through a high quality paper catalog. This is another reason why the web might not be a great shopping medium for cutting tools, but is a great ordering medium.

E-commerce platforms promise to induce the development of **ISCAR's** electronic catalog, not only as a medium for acquiring information but as a platform to increase the company's sales.

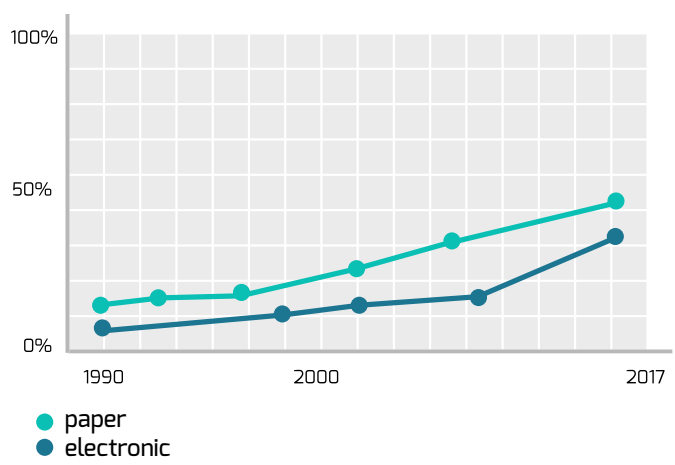

Over time, catalog users have **increased** their use of the **Internet** as the data is **accessible at all times**



**E-commerce** is gaining ground quickly and promises to **change methods** of acquiring information



**ISCAR's** mobile application software or mobile apps were launched in 2012 to run on mobile devices such as smartphones and tablets. Incorporating a similar design to the paper catalog, the mobile device user interface acts as an electronic extension of the hard copy version. The CMS catalog apps are very popular among users, showing high download numbers.

From the surveys which we conduct at **ISCAR** headquarters, we can summarize that paper catalogs are here to stay. Of the different ways to search for information related to **ISCAR** tools, about 35% of **ISCAR's** customers prefer paper while 25% of the customers use the electronic catalog in conjunction with the paper version.

You cannot conduct a successful catalog sales operation without them. Web catalogs appear to be viewed primarily as an ordering mechanism and not a sales medium.

E-commerce is gaining ground quickly and promises to change methods of acquiring information and ordering when integrated with the electronic catalog.

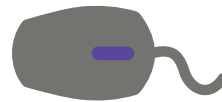

25%

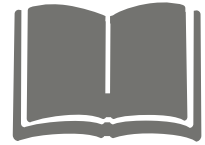

35%

